



Groove™

● Groove™ V2
in Savoye

● Autex Acoustics®,
Australia



A dash of personality

Groove™ is a semi-rigid acoustic panel, router cut with a series of precise, angular designs that bend and distort light. From subtle patterns to hinges and joins for 3D sculptures, Groove adds depth, nuance, and texture. Choose a single color for a tone-on-tone effect, or combine two colors with Groove Duet™ to create a two-tone effect.

To find out more about Groove
visit [autexacoustics.com](https://www.autexacoustics.com)

● Custom Groove™
in Sargazo

● Mā Wai Hakona,
New Zealand





Features and benefits

- Seven patterns
- Endless customization options
- Available on both 1/2" and 1" Cube™ panels
- Peel 'n' Stick backing
- Beveled edge for consistent joins
- Add a soft velour touch and two-tone look with Groove Duet, available with all patterns and custom designs

Applications

- Decorative customization for ceilings and walls in interior spaces

● Custom Groove™
in Flatiron

● Outkast,
Australia



How to specify

Groove is a lightweight but semi-rigid panel router cut with a series of precise, angular designs that bend and distort light. Choose a single color for a tone-on-tone effect, or combine two colors with Groove Duet to create a two-tone effect.

Design

Select from a range of seven patterns.

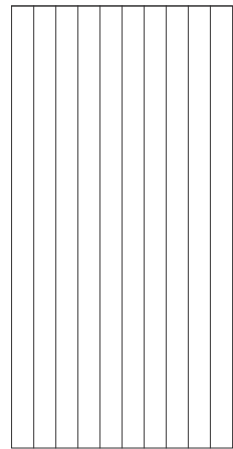

V1

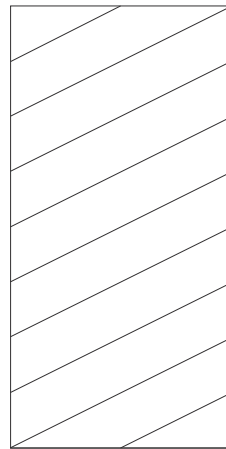

V2

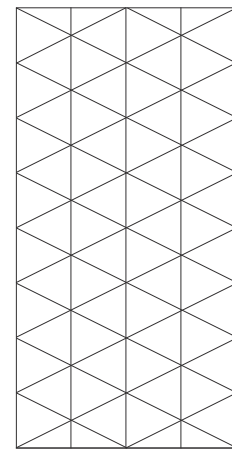

V3

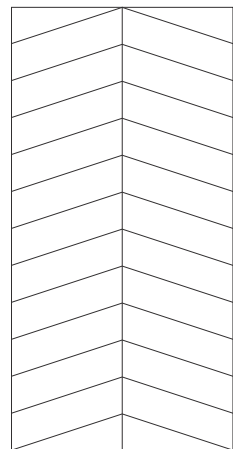

V4

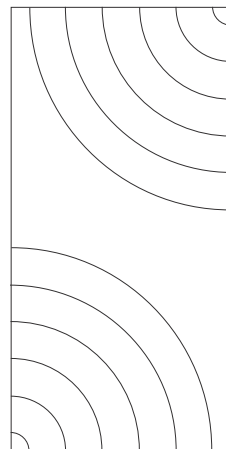

V5

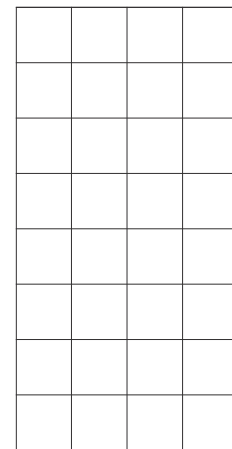

V6

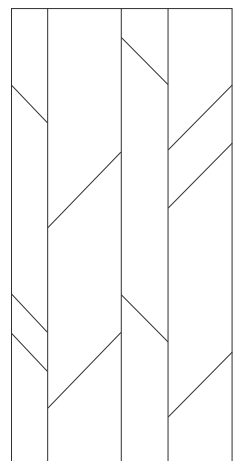

V7

Panel color and thickness

Choose your Groove panel color and thickness.



Available in full Cube color range - refer to page 12
(base product color)

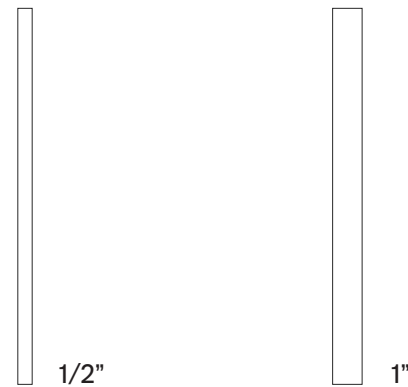

Available in two Cube thicknesses

Groove Duet™ color (optional)

To create a two-tone effect (Duet), select your base color first and then select a top color.



Available in full Vertiface® color range - refer to page 14
(topping product color - velour only)



Pattern options

Choose from our range of pattern options,
or create your own bespoke design.

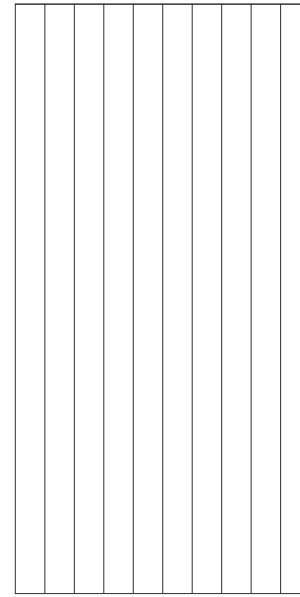

V1

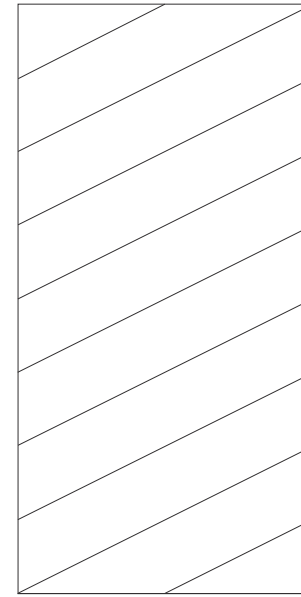

V2

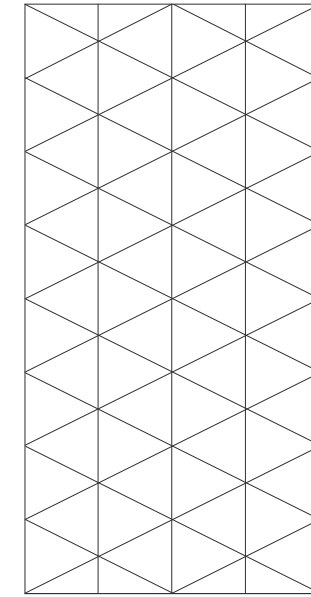

V3

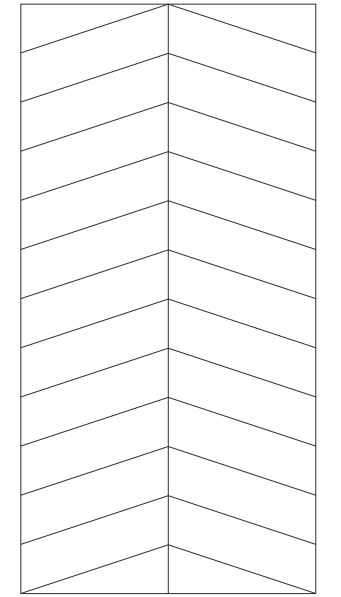

V4

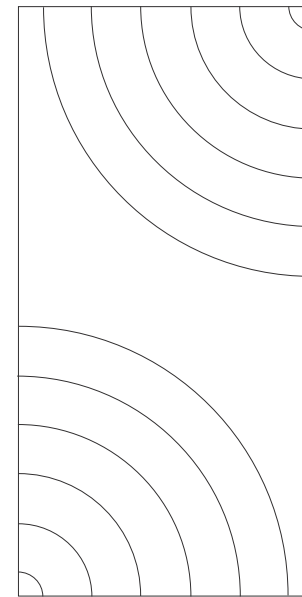

V5

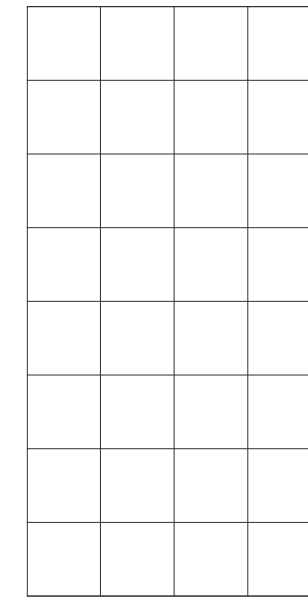

V6

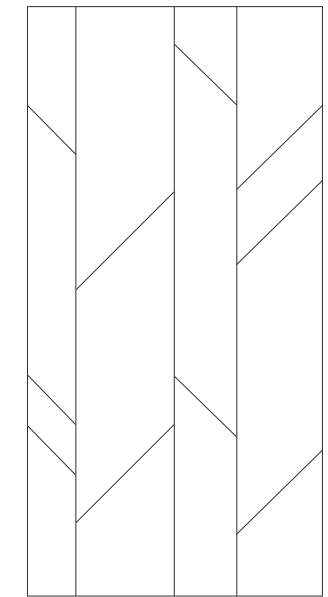

V7

For information on spacing measurements between grooves,
please contact your Autex Acoustics account manager.



Detail options

Our standard angle cut is 30°, which gives Groove its signature finish.

Groove™ details

Panel edges are chamfered to hide panel join.

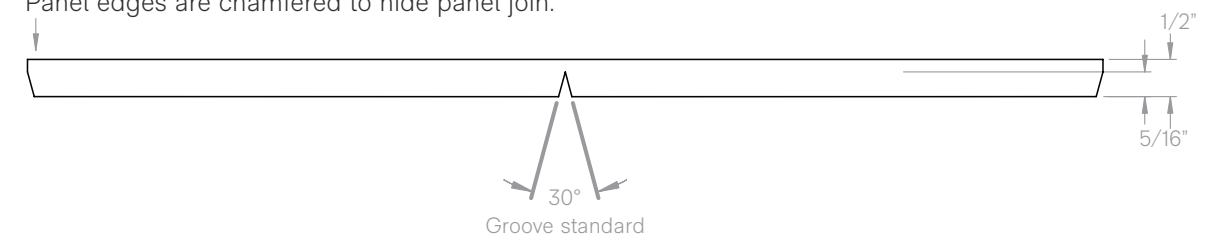

Panel join details

Hidden panel join

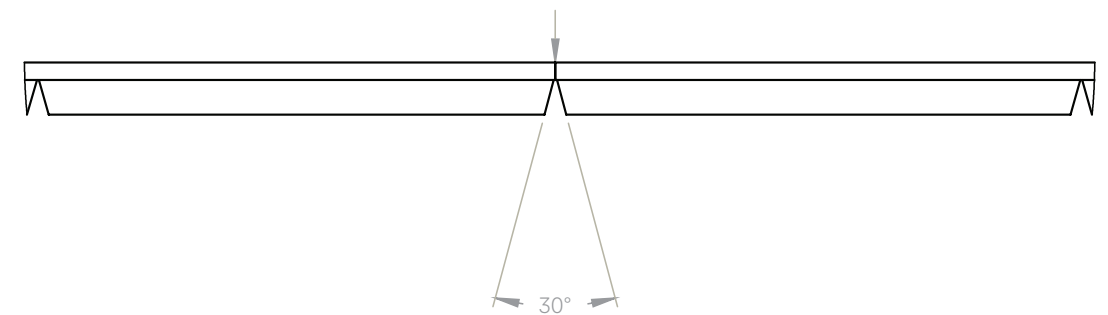



Color options

Choose from our range of Cube colors.
For Groove Duet, select your base color from the options below.



Pavilion



Savoie



Flatiron



Empire



Petronas



Opera



Parthenon



Pinnacle



Caspian



Muralla

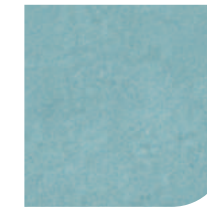

Falling Water



Acros



Gherkin



Tree House



Highland



Beehive



Senado



Canyon



Sargazo



Terrace



Cavalier

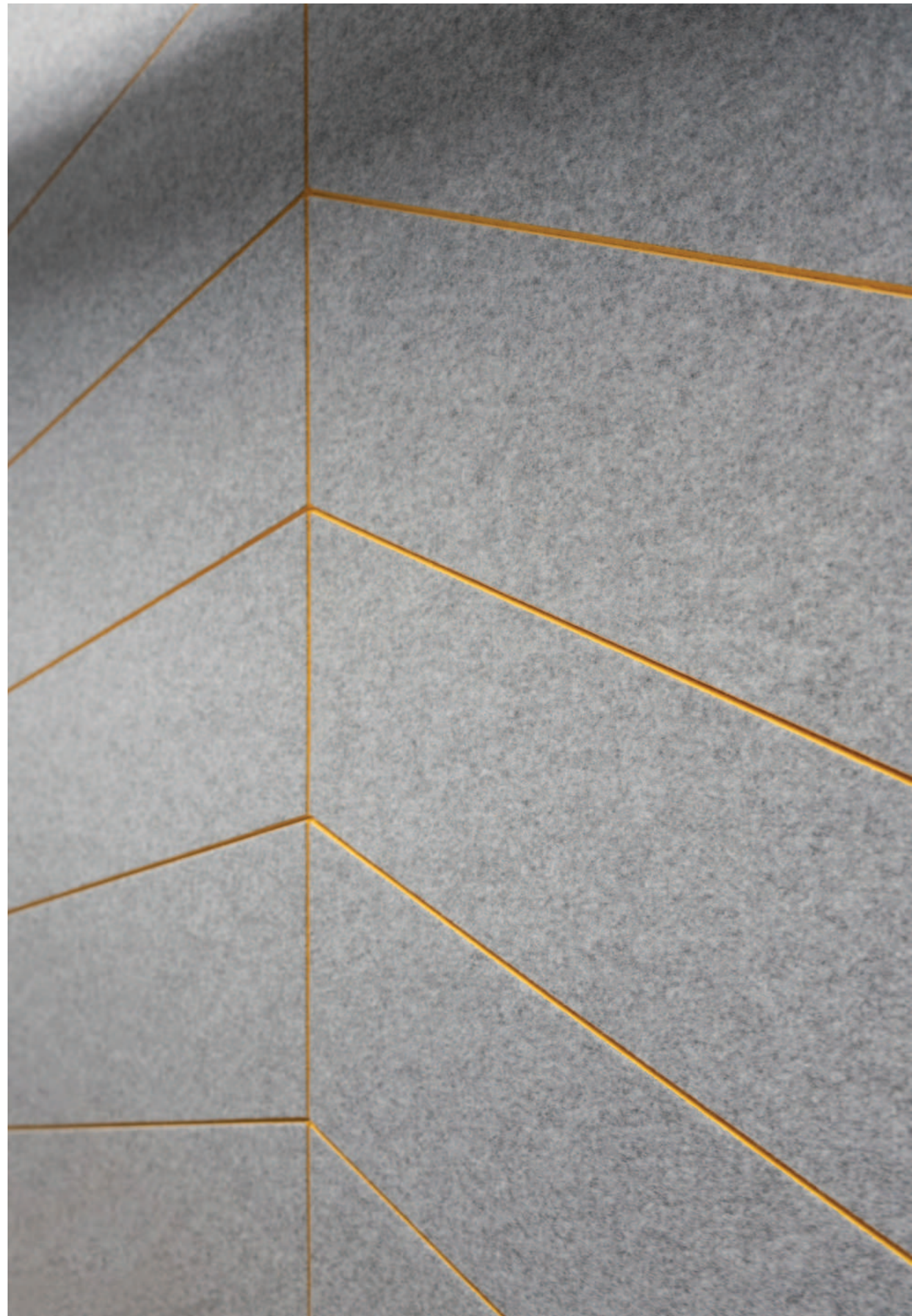

● Ministry of Architecture,
New Zealand

● Groove Duet™ V4 in Flatiron
on Senado base

Groove Duet™ color options

For a soft velour touch and two-tone look, choose your topping color from our range of Vertiface colors.

						
Savoy	Myst	Flatiron	Koala	Empire	Petronas	Opera
						
Parthenon	Ink	Calypso	Porcelain	Electric Blue	Pinnacle	Caspian
						
Muralla	Atlantis	Stonewash	Falling Water	Octane	Spearmint	Sage
						
Jade	Acros	Lime	Granny Smith	Gherkin	Tree House	Highland
						
Beehive	Senado	Simba	Canyon	Vintage	Chilli Red	Blazing Red
						
Sargazo	Terrace	Cavalier				

Customization

As creators and innovators, we understand your pursuit of the bold and unusual, the rare and exceptional—the brave, color-outside-the-lines ideas. Every space you design is unique, therefore, every element— from floor to ceiling— should be tailored to fit. The clean, precise cuts can create anything from subtle patterns to 3D sculptures.



● Custom Groove Duet™ in Acros, Gherkin, and Jade on Tree House base

● Genesis, New Zealand



We are proud to be a carbon neutral organization

We have reduced and balanced all carbon emissions from our business operations, including manufacturing to zero.

We offer entirely carbon neutral products

All our products are carbon neutral with emissions offset through certified carbon credits.

0_t

CO₂-e per ton of product



Sustainability pillars

The five pillars of our sustainability strategy define all aspects of our operations and the products we offer.

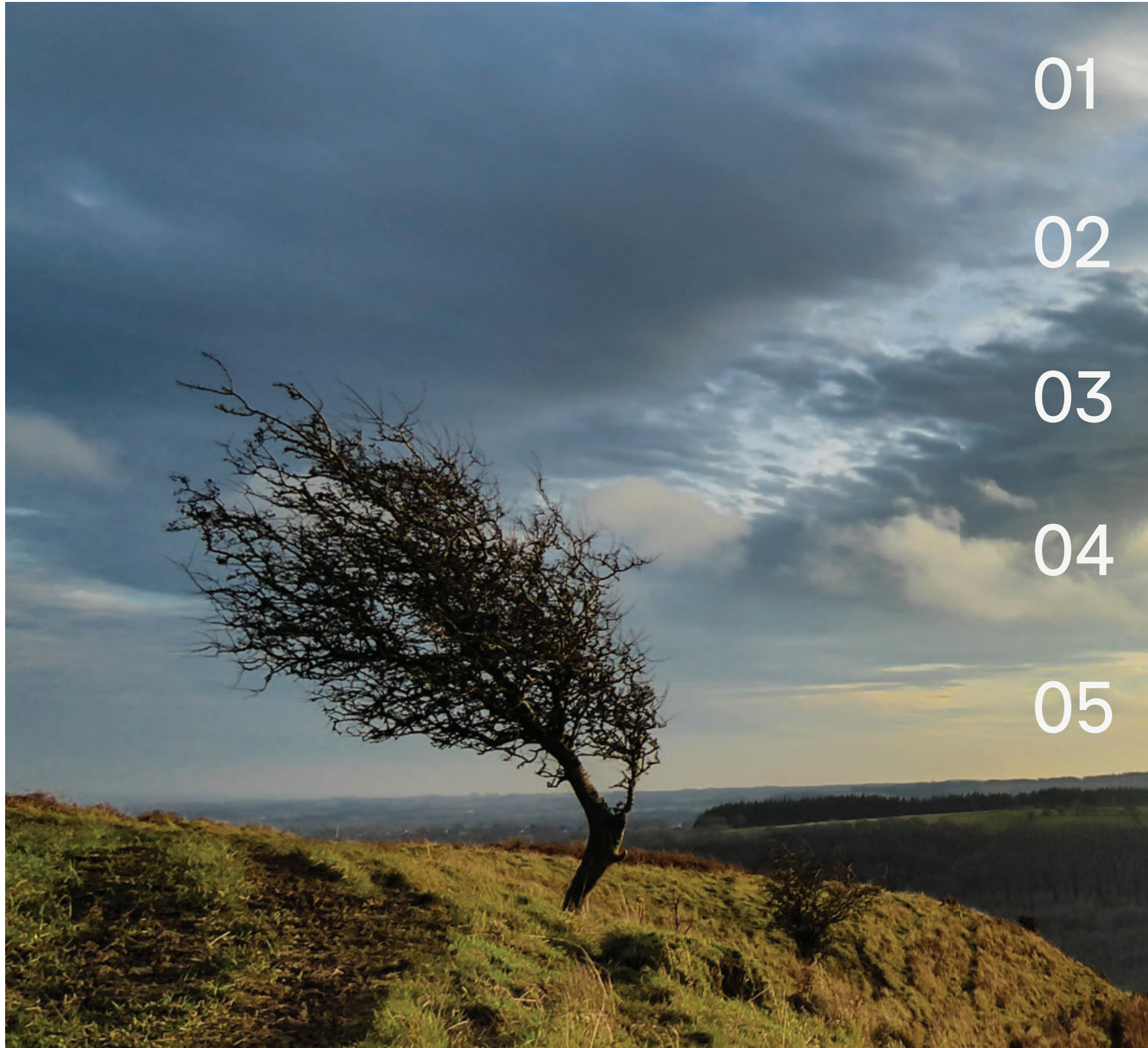

01



Climate change demands climate action We are carbon neutral in everything we do.

02



Closing the loop We are advocates for closing the loop on waste. We contribute by using recycled material through to creating recyclable products.

03



Sustainable supply chain We carefully select responsible suppliers to eliminate unethical practices and encourage good working conditions.

04



Supporting wellbeing in buildings All our products are made using only safe materials. No harmful chemicals are used in any stage of our process.

05



Operating a business for purpose and profit We strive to have a positive impact on our environment, our people, and the next generation.

In everything we do



Our journey to carbon neutrality

1967

Founded in Auckland, NZ, creating underfelt for the flooring industry

1990

Established a zero-waste production line

2012

Reclaimed waste trimmings, **reducing raw material use and associated emissions**

2017

First EPD's published and started measuring **greenhouse gas emissions**

2020

Dematerialization project which reduced raw material use **by 30% for core product**

2021

We balanced all emissions from our **acoustic products to zero**

2022

We balanced all emissions from our **global operations to zero**

Australia
New Zealand
United States of America
United Kingdom



How we're fighting climate change

The climate crisis is the biggest issue of our generation. As a product designer and manufacturer, we have an opportunity to help improve the carbon impact of our industry.

Our operational carbon emissions

We are a carbon neutral business. We actively monitor the carbon emissions of our entire operation to better understand our carbon footprint and how we can further reduce emissions. We have an internal strategy to reduce our carbon emissions and have successfully delivered a number of carbon reduction initiatives within our operations. Any carbon emissions that are currently unavoidable are offset through certified carbon credits. We have a commitment to purchase only verified carbon credits that are retired on robust registers to ensure we are driving positive change.

Key business activities contributing to our operational emissions

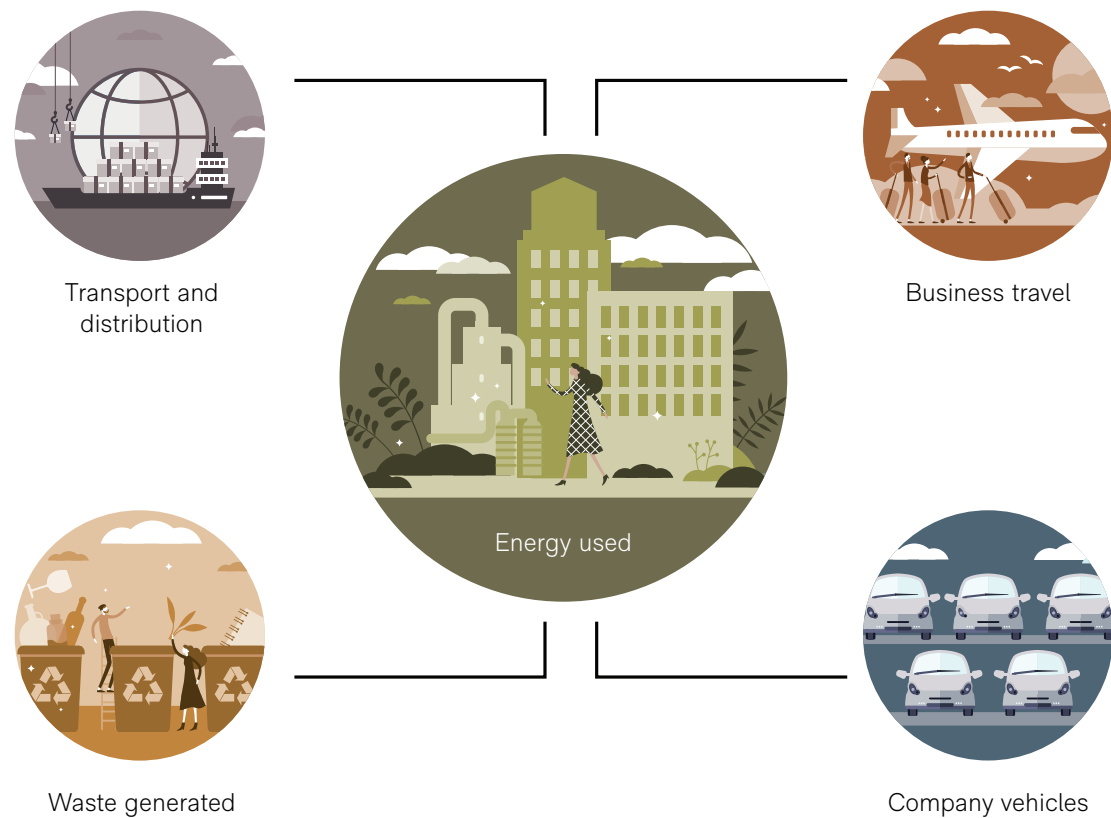

Embodied carbon of our products

Our products are carbon neutral, and we are the first business in our industry to include the cost of carbon in our products. We consider this an investment in present and future generations, and simply a cost of doing business. We calculate the embodied carbon of our products, from the raw material to the manufacturing gate, using industry recognised ISO standards. We have reduced the carbon footprint of our products through smart design and efficient manufacturing. While the embodied carbon of our products is low, they still do have a carbon impact. We mitigate this through our Carbon Neutral Product Initiative by offsetting the equivalent emissions using certified carbon credits. These carbon credits are generated from projects focused on renewable energy, fuel switching, and reforestation around the world.

Key activities contributing to the embodied carbon of our products

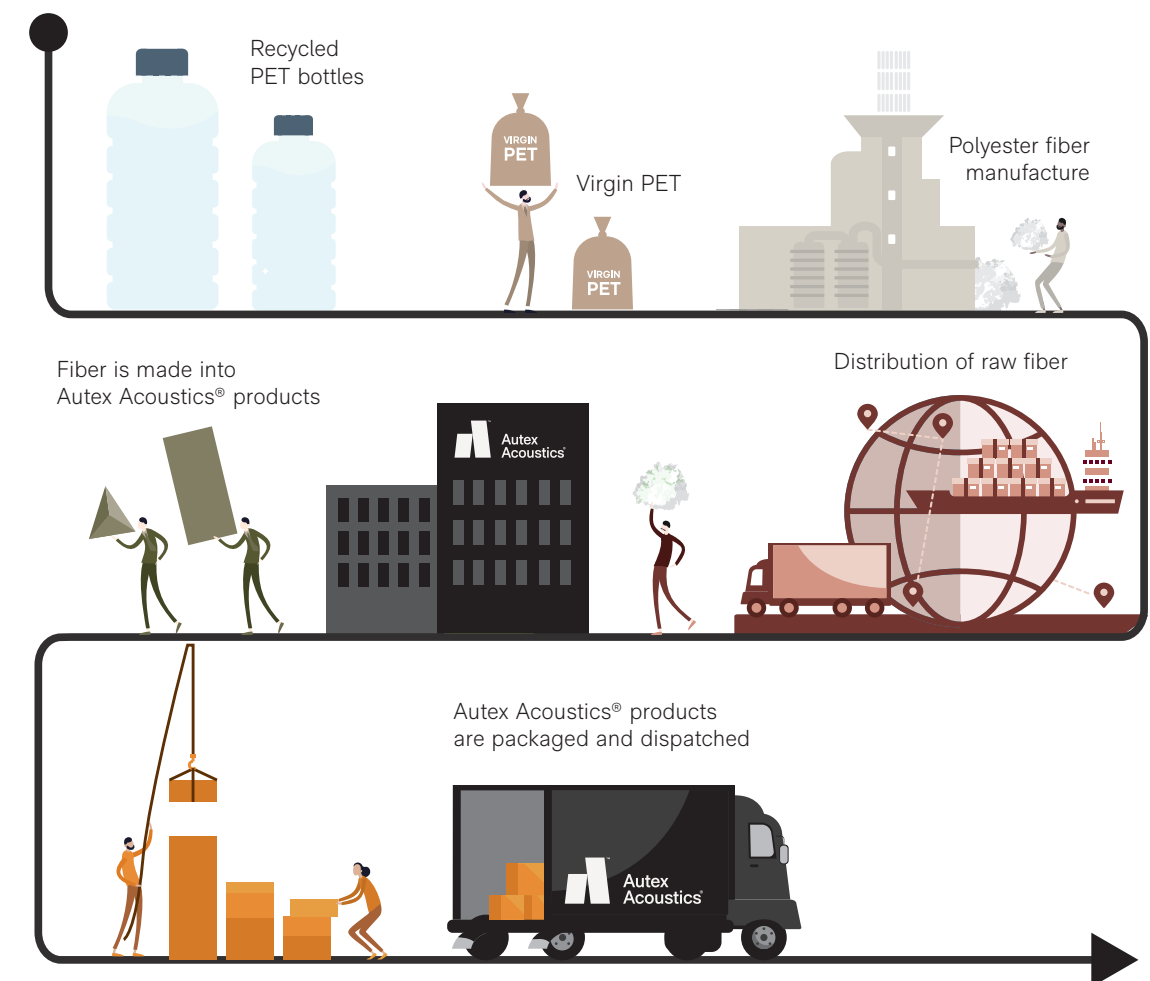



Certifications

Certifying your green building

Autex Acoustics products meet criteria for WELL, LEED, Green Star, and BREEAM building rating systems, helping you achieve certification for your project. For support and guidance on available rating system points please visit www.autexglobal.com, or speak with your Autex Acoustics account manager.



Mindful Materials

The Mindful Materials library provides transparent information on product environmental certifications and ingredients to help you make informed decisions when specifying. Explore our product range on the Mindful Materials library mindfulmaterials.com



Environmental Product Declaration

An Environmental Product Declaration (EPD) is a document that communicates information about the life-cycle environmental impact of a product, including embodied carbon. Our EPDs are created and verified in accordance with ISO 14025 and EN 15804, used for construction products and services.



GreenRate – Level A

GreenRate is a multi-attribute environmental certification that scores products on a range of environmental, health, and social measures. Autex Acoustics products are certified to achieve GreenRate Level A. Level A is the highest GreenRate level and demonstrates the highest level of product sustainability.



Declare – International Living Future Institute

The ingredients in our products have been reviewed against the Living Future Challenge Red List and achieve a Third-Party Verified 'Red List Free' status.



Products achieve the highest 'LBC Red List Free' status when:

- Ingredients are 100% disclosed and are not found in the Red List
- Products are shown to meet VOC emissions limits

We assure the accuracy of our certifications by having our Declare labels independently verified by a third party expert.



Health Product Declaration

A Health Product Declaration (HPD) is a document that reports the ingredients of a product and the health effects associated with these ingredients. A Health Product Declaration has been generated for each of our products.



CDPH Standard

CDPH Standard Method (CA Section 01350) is a widely used standard to evaluate building products for low volatile organic chemicals (VOC) and formaldehyde emissions. All Autex Acoustics products meet the limits set by CDPH and the LEED building rating scheme.



ISO Certifications

ISO 14001 – Environmental Management

Autex Acoustics manufactures under environmental management processes that are ISO certified. This certification gives assurance that we manage any environmental impacts within our operations.



ISO 9001 – Quality Management

Autex Acoustics has a strict quality management system that is ISO certified. Robust quality processes from raw material through to product release help ensure our products meet expectations.



ISO 45001 – Health and Safety Management

Autex Acoustics manufacturing operations have an ISO 45001 certified Health and Safety Management System to ensure the safety and wellbeing of our people.



In everything we do

● **New Zealand**

702-718 Rosebank Road,
Private Bag 19988
Avondale 1746, Auckland
T 0800 428 839
T +64 9 828 9179
autexacoustics.co.nz

● **Australia**

285 Swan Street,
Richmond, VIC 3121
T 1800 678 160
T +61 3 9450 6700
autexacoustics.com.au

● **United Kingdom**

Unit J4, Lowfields Way,
Lowfields Business Park,
Elland, West Yorkshire
HX5 9DA
T +44 0 142 241 8899
autexacoustics.co.uk

● **United States**

1630 Dan Kipper Drive,
Riverside, CA 92507
T +1 424 203 1813
autexacoustics.com

Autex is an ISO certified organisation encompassing Quality (ISO 9001), Environmental (ISO 14001), and Health and Safety (ISO 45001). Brand names and logos are registered or unregistered trademarks owned or used under license by Autex Industries Limited or other members of the Autex Group. © Copyright 2024 Autex Industries Ltd. All rights reserved. It is the user's responsibility to determine if the product and information presented in this document is suitable for the intended application by engaging a suitably qualified consultant. The information contained in this document is correct to the best of our knowledge at the date of its publication. To verify that this document is the most current publication please check our website or contact your Autex Acoustics account manager.