

HORIZON™ PANEL SUSPENDED

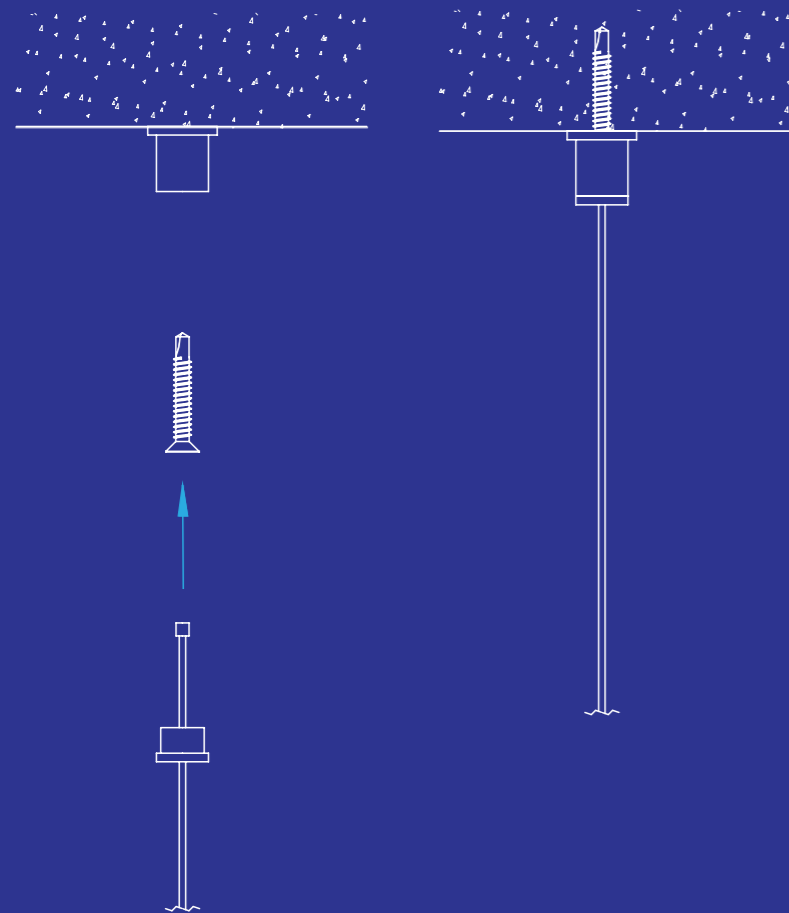

STEP 1

Mark out and fix ceiling connector to ceiling substrate as shown and use the appropriate fixing layout for your chosen Horizon™ panel design. Refer to the fixing positions page.

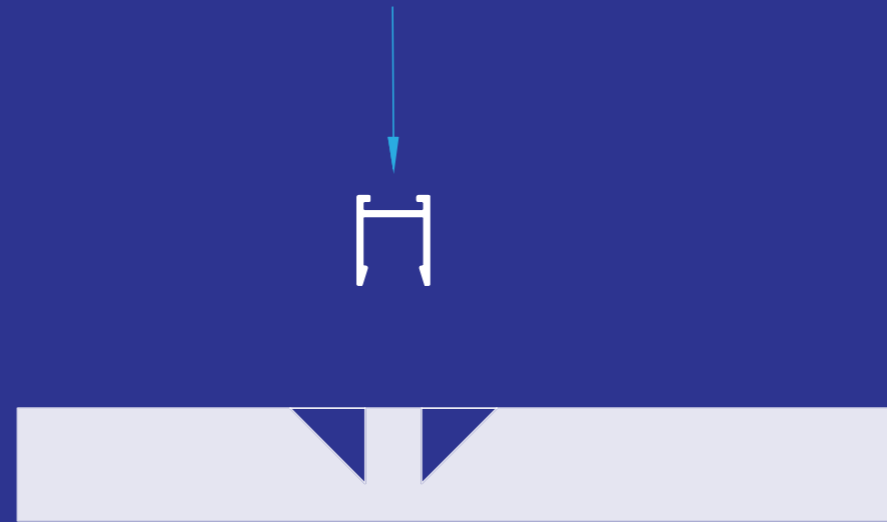

STEP 2

Place Horizon panel on a clean flat surface. Using a soft faced hammer, gently tap the appropriate length of Frontier Channel into the grooves on the top of the panel. It is important that the extrusion is not bent or deformed during this process

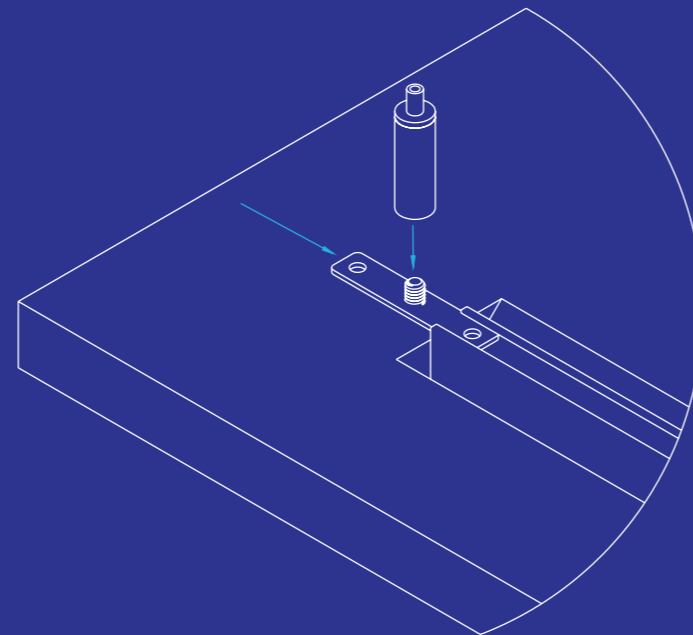

STEP 3

Slide the attachment plate into the groove in the top of the extrusion and screw the cable adjuster onto the attachment plate. Tighten adjuster to lock into the correct position. Refer to the fixing positions page.

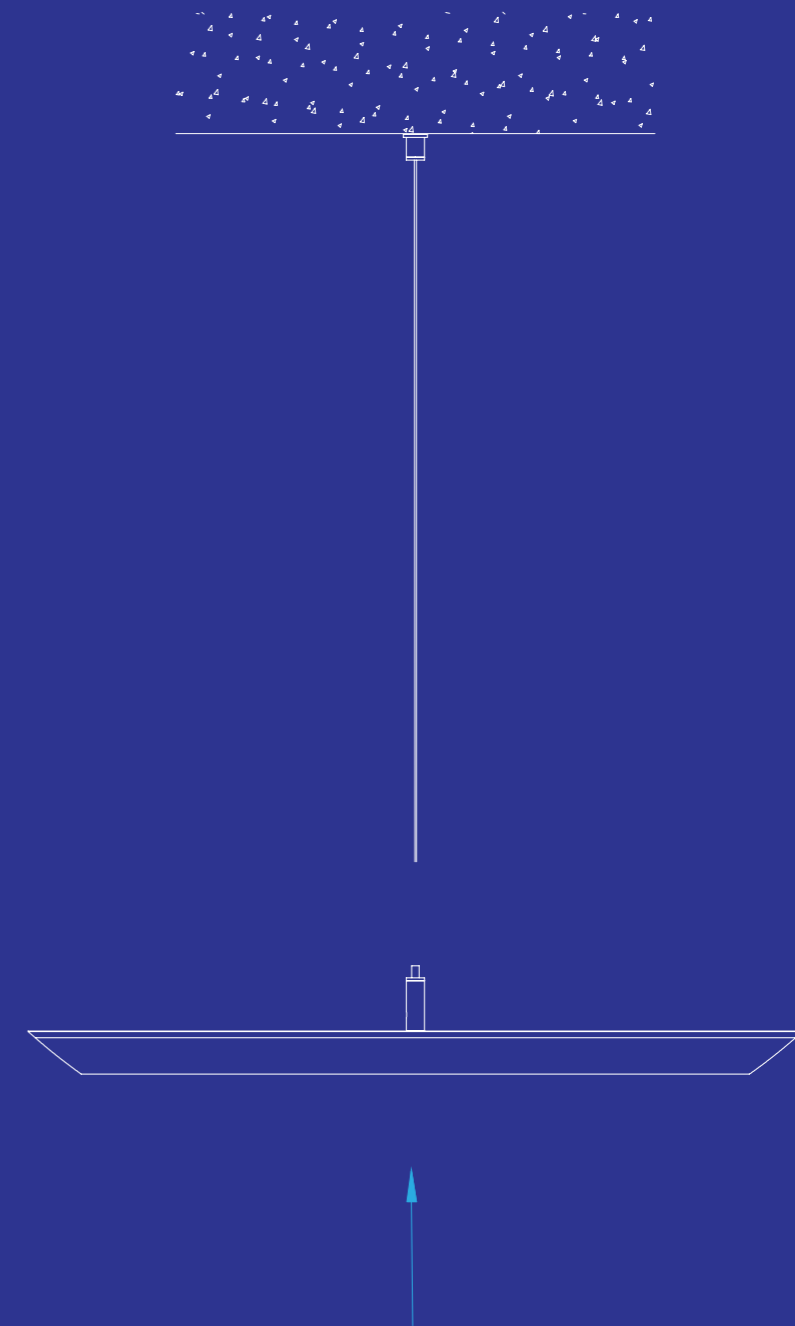

STEP 4

Lift panel up and thread the cable ends into the hole on the top of the adjuster barrel. Pull cable through until panel is at the desired height, the cable can be released by pressing on the top of the adjuster if required.

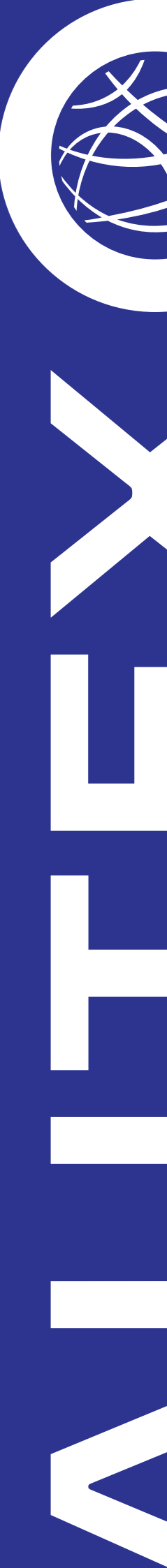

HORIZON™

WALL MOUNTED

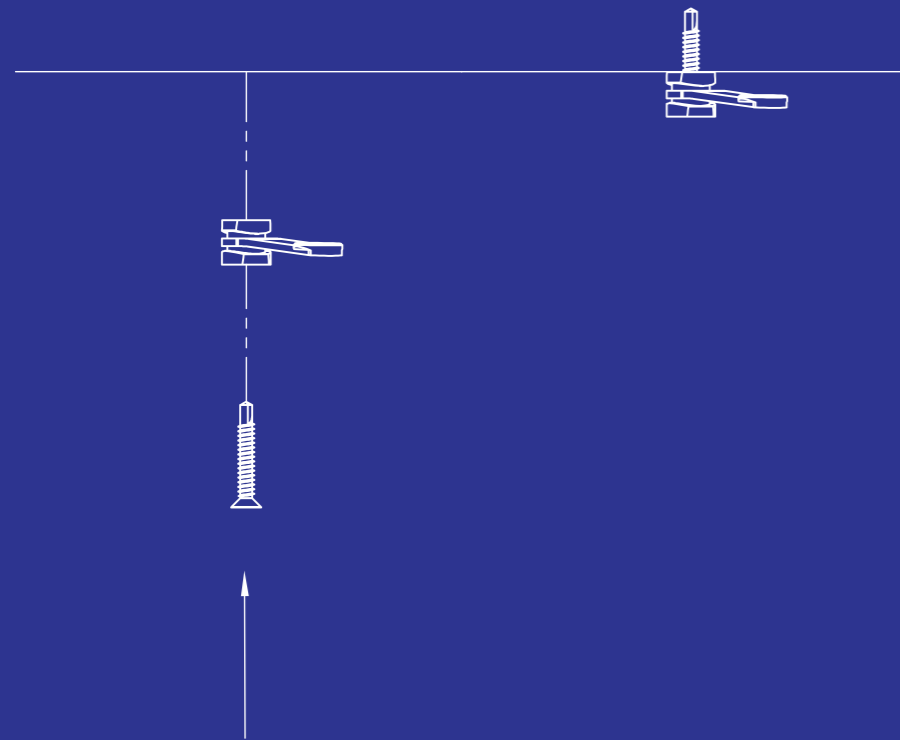

STEP 1

Mark out and fix Frontier™ Clip to wall substrate as shown. Do not over tighten, clip must be firm, but able to turn on screw use the appropriate fixing layout for your chosen Horizon panel design. Refer to the fixing positions page.



STEP 2

Place Horizon panel on a clean flat surface. Using a soft faced hammer gently tap the appropriate length of Frontier Channel into the grooves on the top of the panel. It is important that the extrusion is not bent or deformed during this process.

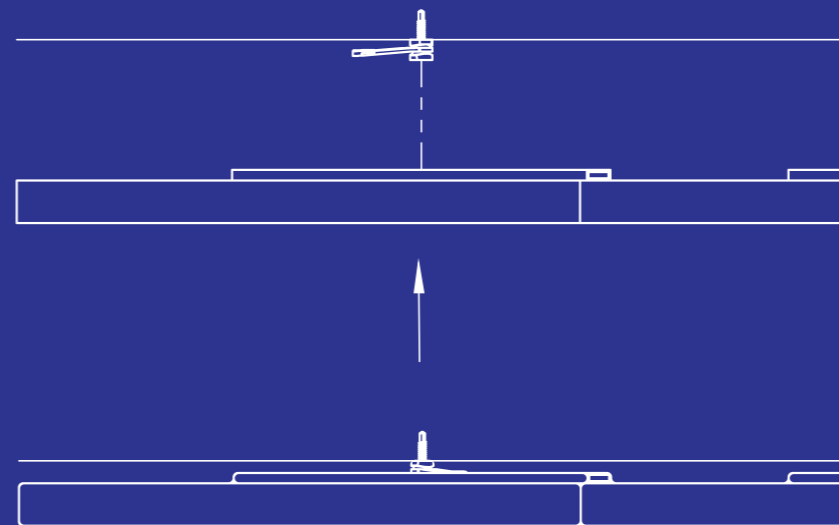

STEP 3

With Frontier clip handle at 90 degrees to the channel, offer up the panel to the clips.

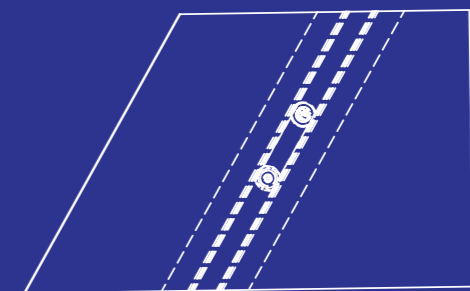
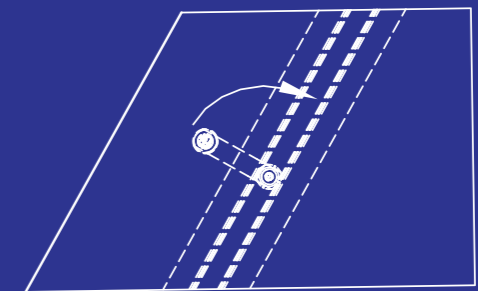

STEP 4

Once clips are seated the handle may be turned 90 degrees to lock into place.



HORIZON™

FIXING POSITIONS

